

	4141 55	4141 56
U_{cpv}	720 V $\overline{\text{---}}$	1200 V $\overline{\text{---}}$
I_{scpv}	50 A	125 A
T° mini/maxi	-10°C \rightarrow +70°C	

mini : 4 mm ²	mini : 4 mm ²
2 x 16 mm ² 1 x 25 mm ²	2 x 10 mm ² 1 x 25 mm ²

(*) Min. : 2,5 / 3 Nm

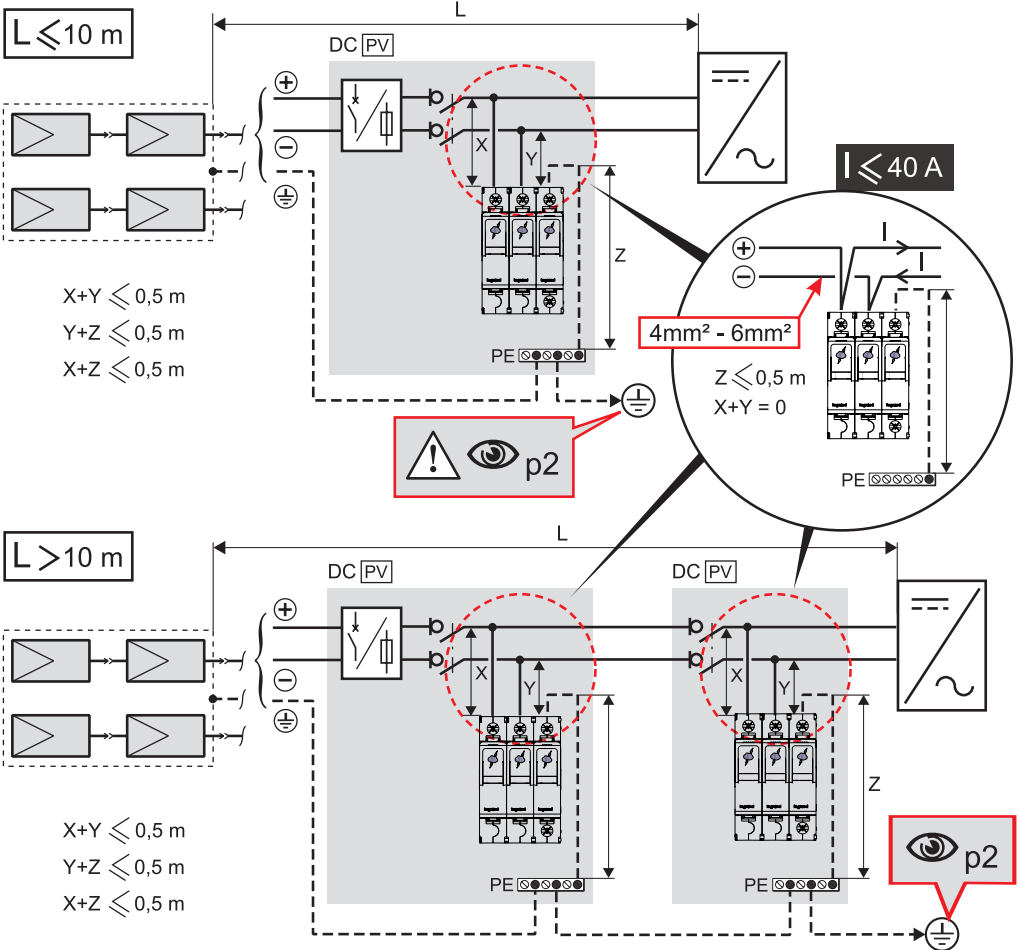

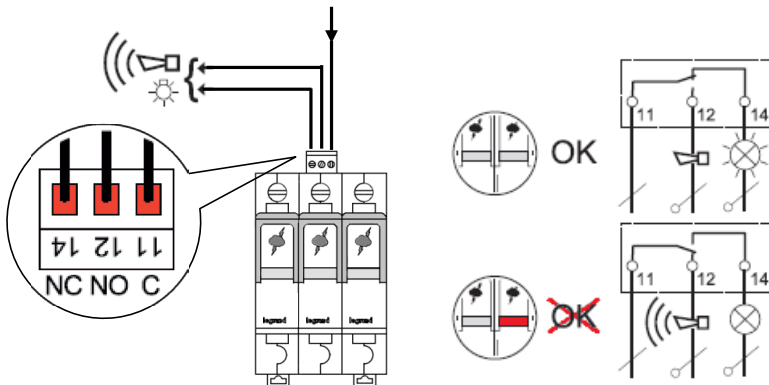
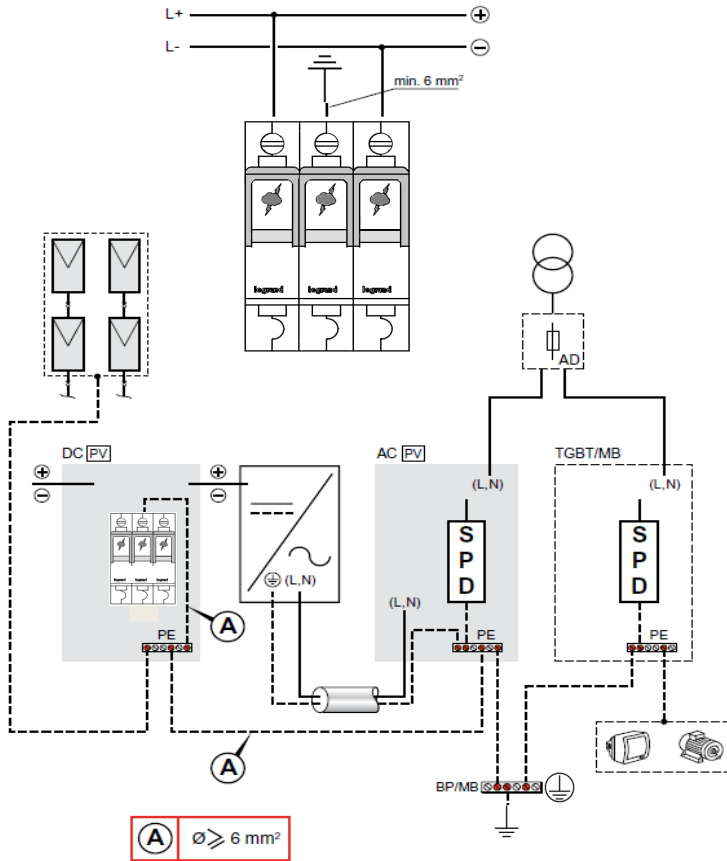
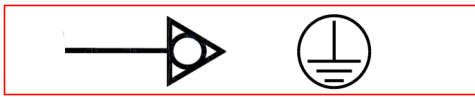

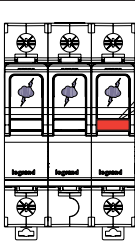



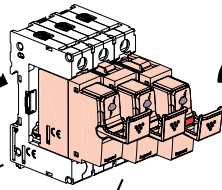





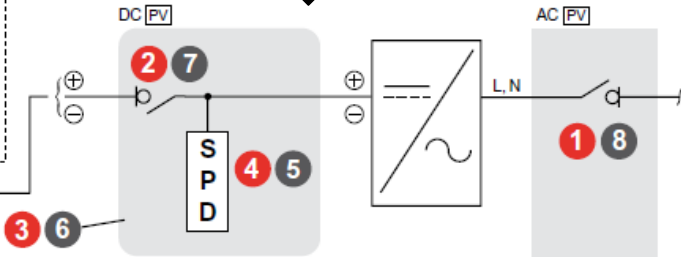
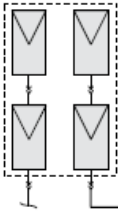

OK



4 141 55	4 141 56
 4 141 55 x 3 (+/- ⊥)	 4 141 56 x 3 (+/- ⊥)

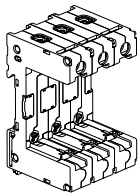

1		OFF	8		ON
2		OFF	7		ON
3			6		
4			5		

**• Recommendations**

L'installation ne doit pas être remise sous tension (DC/AC) cassettes absentes.

• Recommendations

The installation must not be switched on again (DC/AC) when no replacement module is fitted.

• Recomendaciones

La instalación no debe conectarse a la corriente (CC/CA) sin la presencia de los casetes.

• Recommendations :

- Ne pas installer des parafoudres dans des locaux à risques d'incendie ou d'explosion sans disposition spécifique.
- Déconnecter les parafoudres avant de vérifier la résistance d'isolement de l'installation.

• Recommendations :

- Do not install voltage surge protectors in premises exposed to risk of fire or explosion without specific precautions.
- Disconnect the voltage surge protectors before checking the installation's insulation resistance.

• Recomendaciones :

- No instalar los limitadores de sobretensión en locales con riesgo de incendio o explosión, sin disposición específica.
- Desconectar los limitadores antes de verificar la resistencia de aislamiento de la instalación.

⚠ Consignes de sécurité**FR BE CA LU CH**

Ce produit doit être installé conformément aux règles d'installation et de préférence par un électricien qualifié. Une installation et une utilisation incorrectes peuvent entraîner des risques de choc électrique ou d'incendie. Avant d'effectuer l'installation, lire la notice, tenir compte du lieu de montage spécifique au produit.

Ne pas ouvrir, démonter, altérer ou modifier l'appareil sauf mention particulière indiquée dans la notice. Tous les produits Legrand doivent exclusivement être ouverts et réparés par du personnel formé et habilité par Legrand. Toute ouverture ou réparation non autorisée annule l'intégralité des responsabilités, droits à remplacement et garanties.

Utiliser exclusivement les accessoires de la marque Legrand.

⚠ Safety instructions**GB CA IN IE US**

This product should be installed in line with installation rules, preferably by a qualified electrician. Incorrect installation and use can lead to risk of electric shock or fire.

Before carrying out the installation, read the instructions and take account of the product's specific mounting location.

Do not open up, dismantle, alter or modify the device except where specifically required to do so by the instructions. All Legrand products must be opened and repaired exclusively by personnel trained and approved by Legrand. Any unauthorised opening or repair completely cancels all liabilities and the rights to replacement and guarantees.

Use only Legrand brand accessories.

⚠ Consignas de seguridad**ES CL CO CR MX PE US VE**

Este producto debe instalarse conforme a las normas de instalación y preferiblemente por un electricista cualificado. Una instalación y una utilización incorrectas pueden entrañar riesgos de choque eléctrico o de incendio. Antes de efectuar la instalación, leer las instrucciones, tener en cuenta el lugar de montaje específico del producto. No abrir, desmontar, alterar o modificar el aparato salvo que esto se indique específicamente en las instrucciones. Todos los productos Legrand deben ser abiertos y reparados exclusivamente por personal formado y habilitado por Legrand. Cualquier apertura o reparación no autorizada anula la totalidad de las responsabilidades, derechos a sustitución y garantías.

Utilizar exclusivamente los accesorios de la marca Legrand.

⚠ Istruzioni di sicurezza**IT CH**

Questo prodotto deve essere installato in conformità con le regole d'installazione e di preferenza da un elettricista qualificato. L'eventuale installazione e utilizzo improprio dello stesso possono comportare rischi di shock elettrico o incendio. Prima di procedere all'installazione, leggere attentamente le istruzioni associate e individuare un luogo di montaggio idoneo in funzione del prodotto.

Non aprire, smontare, alterare o modificare l'apparecchio eccetto speciale menzione indicata nel manuale. Tutti i prodotti Legrand devono essere esclusivamente aperti e riparati da personale adeguatamente formato e autorizzato da Legrand.

Qualsivoglia apertura o riparazione non autorizzata comporta l'esclusione di eventuali responsabilità, diritti alla sostituzione e garanzie.

Utilizzare esclusivamente accessori a marchio Legrand.